



by Schneider Electric

User Manual

Smart-UPSTM Uninterruptible Power Supply

750/1000 VA

100/120/230 Vac

Rack Mount 1U

For Professional Business Applications – Not For Consumer Use

Important Safety Information

SAVE THESE INSTRUCTIONS - This manual contains important instructions that should be followed during installation and maintenance of the Smart-UPS and batteries.

Read these instructions carefully and look at the equipment to become familiar with the equipment before trying to install, operate, service or maintain it. The following special messages may appear throughout this manual or on the equipment to warn of potential hazards or to call attention to information that clarifies or simplifies a procedure.



The addition of this symbol either to a “Danger” or “Warning” safety label indicates that an electrical hazard exists which will result in personal injury if the instructions are not followed.



This is the safety alert symbol. It is used to alert you to potential personal injury hazards. Obey all safety messages that follow this symbol to avoid possible injury or death.

DANGER

DANGER indicates a hazardous situation which, if not avoided, **will result in** death or serious injury.

WARNING

WARNING indicates a hazardous situation which, if not avoided, **could result in** death or serious injury.

CAUTION

CAUTION indicates a hazardous situation which, if not avoided, **could result in** minor or moderate injury.

NOTICE

NOTICE is used to address practices not related to physical injury.

Product Handling Guidelines



<18 kg
<40 lb



18-32 kg
40-70 lb



32-55 kg
70-120 lb



>55 kg
>120 lb



Safety and General Information

- Adhere to all national and local electrical codes.
- All wiring must be performed by a qualified electrician.
- Changes and modifications to this unit not expressly approved by APC could void the warranty.
- This UPS is intended for indoor use only.
- Do not operate this UPS in direct sunlight, in contact with fluids, or where there is excessive dust or humidity.
- Do not operate the UPS near open windows or doors.
- Be sure the air vents on the UPS are not blocked. Allow adequate space for proper ventilation.
Note: Allow 20 cm clearance on both front and rear sides of the UPS.
- For a UPS with a factory installed power cord, connect the UPS power cable directly to a wall outlet. Do not use surge protectors or extension cords.
- The equipment is heavy. Always practice safe lifting techniques adequate for the weight of the equipment.

- The batteries are heavy. Remove the batteries before installing the UPS and External Battery Packs (XLBPs), in a rack.
- The battery typically lasts for two to three years. environmental factors impact battery life. Elevated ambient temperatures, poor quality AC power, and frequent short duration discharges will shorten battery life.
- Additional safety information can be found in the Safety Guide supplied with this unit.

Deenergizing safety

- The UPS contains internal batteries and may present a shock hazard even when disconnected from AC and DC power.
- The AC and DC output connectors may be energized by remote or automatic control at any time.
- Before installing or servicing the equipment check that the:
 - Mains circuit breaker is in the **OFF** position
 - Internal UPS batteries are removed
 - XLBP battery modules are disconnected

Electrical safety

- For models with a hardwired input, the connection to the branch circuit (mains) must be performed by a qualified electrician.
- 230 V models only: In order to maintain compliance with the EMC directive for products sold in Europe, output cords attached to the UPS must not exceed 10 meters in length.
- The protective earth conductor for the UPS carries the leakage current from the load devices (computer equipment). An insulated ground conductor is to be installed as part of the branch circuit that supplies input power to the UPS. The conductor must have the same size and insulation material as the grounded and ungrounded branch circuit supply conductors. The conductor will typically be green and with or without a yellow stripe.
- The UPS input ground conductor must be properly bonded to protective earth at the service panel. If the UPS input power is supplied by a separately derived system, the ground conductor must be properly bonded at the supply transformer or motor generator set.

Battery safety

CAUTION

RISK OF HYDROGEN SULPHIDE GAS AND EXCESSIVE SMOKE

- Replace the battery at least every 5 years or at the end of its service life, whichever is earlier.
- Replace the battery immediately when the UPS indicates battery replacement is necessary.
- Replace batteries with the same number and type of batteries as originally installed in the equipment.
- Replace the battery immediately when the UPS indicates a battery overtemperature condition, or when there is evidence of electrolyte leakage. Power off the UPS, unplug it from the AC input, and disconnect the batteries.
- *Replace all battery modules (including the modules in External Battery Packs) which are older than one year, when installing additional battery packs or replacing the battery module(s).

Failure to follow these instructions could result in equipment damage and minor or moderate injury.

* Contact APC by Schneider Electric Customer Support to determine the age of the installed battery modules.

- Do not operate the UPS until the batteries have been replaced.
- Servicing of batteries should be performed or supervised by personnel knowledgeable of batteries and the required precautions. Keep unauthorized personnel away from batteries.

- Batteries typically last for two to three years. Environmental factors impact battery life. Elevated ambient temperatures, poor quality utility power, and frequent short duration discharges will shorten battery life. Batteries should be replaced before end of life.
- Schneider Electric uses Maintenance-Free sealed Lead Acid batteries. Under normal use and handling, there is no contact with the internal components of the battery. Over charging, over heating or other misuse of batteries can result in a discharge of battery electrolyte. Released electrolyte is toxic and may be harmful to the skin and eyes.
- CAUTION: Do not dispose of batteries in a fire. The batteries may explode.
- CAUTION: Do not open or mutilate batteries. Released material is harmful to the skin and eyes and may be toxic.
- CAUTION: Before replacing batteries, remove conductive jewelry such as chains, wrist watches, and rings. High energy through conductive materials could cause severe burns.
- CAUTION: Failed batteries can reach temperatures that exceed the burn thresholds for touchable surfaces.
- CAUTION: A battery can present a risk of electrical shock and high short circuit current. The following precautions should be observed when working on batteries:
 - Disconnect the charging source prior to connecting or disconnecting battery terminals.
 - Do not wear any metal objects including watches and rings.
 - Do not lay tools or metal parts on top of batteries.
 - Use tools with insulated handles.
 - Wear rubber gloves and boots.
 - Determine if battery is either intentionally or inadvertently grounded. Contact with any part of a grounded battery can result in electric shock and burns by high short-circuit current. The risk of such hazards can be reduced if grounds are removed during installation and maintenance by a skilled person.

General information

- Always recycle used batteries.
- Recycle the package materials or save them for reuse.
- Select a location sturdy enough for the combined weight of the units.
- Operate the UPS within the specified environmental limits.
- Be sure to deliver the used battery to a recycling facility or ship it to APC by Schneider Electric in the replacement battery packing material.

Radio Frequency Warning

WARNING: This is a category C2 UPS product. In a residential environment, this product may cause radio interference, in which case the user may be required to take additional measures.

NOTE: This equipment has been tested and found to comply with the limits for a Class A digital device, pursuant to part 15 of the FCC Rules. These limits are intended to provide reasonable protection against harmful interference when the equipment is operated in a commercial environment. This equipment generates, uses, and can radiate radio frequency energy and, if not installed and used in accordance with the instruction manual, may cause harmful interference to radio communications. Operation of this equipment in a residential area is likely to cause harmful interference in which case users will be required to correct the interference at their own expense.

Introduction

The APC™ by Schneider Electric Smart-UPS™ is a high performance uninterruptible power supply (UPS). The UPS provides protection for electronic equipment from utility power blackouts, brownouts, sags, surges, small utility power fluctuations and large disturbances. The UPS also provides battery backup power for connected equipment until utility power returns to specified levels or the batteries are fully discharged.

This user manual is available on the enclosed CD and on the APC by Schneider Electric web site, www.apc.com.

Installation

NOTE: Read the Safety Instruction sheet before installing the UPS.

Unpacking

Inspect the UPS upon receipt. APC by Schneider Electric designed robust packaging for your product. However, accidents and damage may occur during shipment. Notify the carrier and dealer if there is damage.

The packaging is recyclable; save it for reuse or dispose of it properly.

Check the package contents. The package contains the UPS, the front bezel, a literature kit containing one CD, one serial cable, one USB cable, product documentation and Safety Information. The package also includes rails, brackets, and a hardware packet, (necessary for rack mounting the UPS).

230V models: Two IEC jumper cables are included and a utility connector plug is included for use on servers with permanently attached power cords.

NOTE: The UPS is shipped with the battery disconnected.

Positioning the UPS

Place the UPS where it will be used. The UPS is heavy. Select a location sturdy enough to handle the weight.

Do not operate the UPS where there is excessive dust or the temperature and humidity are outside the specified limits.

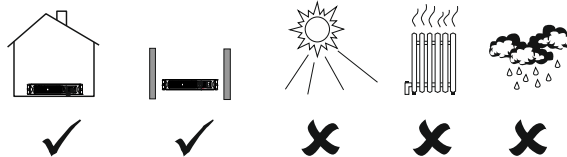

Placement

0°- 40°C (32°-104°F)
0-95% Relative Humidity

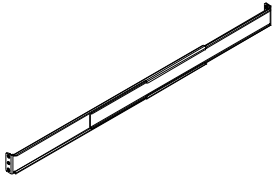

Installing the Rails in the Rack

The UPS fits in a standard 46.5-cm (19-inch) rack. Mounting brackets and rails are packaged separately within the main box. Cleats for rack mounting are preinstalled on the UPS.

	8		2
	8		

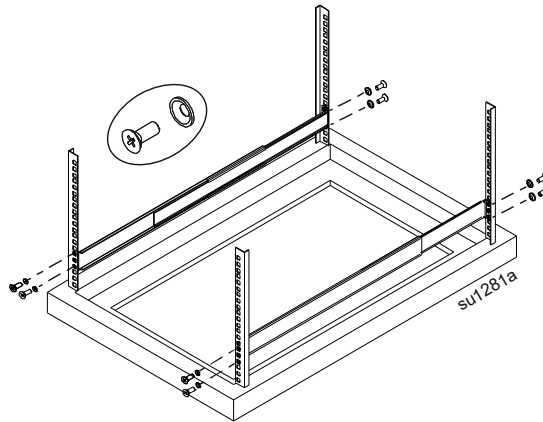

Mounting the UPS in a Rack

The UPS is heavy. To lighten it, you may remove the battery before mounting the unit in the rack (Steps 1 and 2).

Step 1

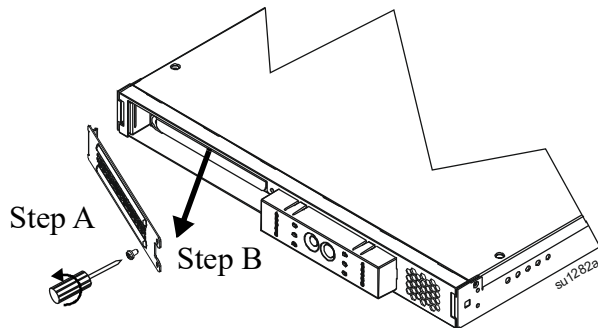

Install the UPS at or near the bottom of the rack.

Step 2

NOTE: Be careful. The battery is heavy.

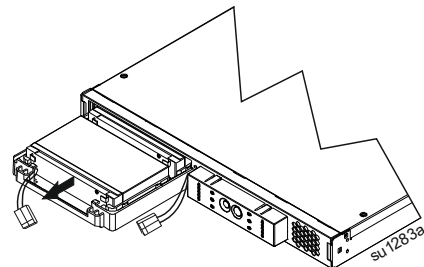

Step 3

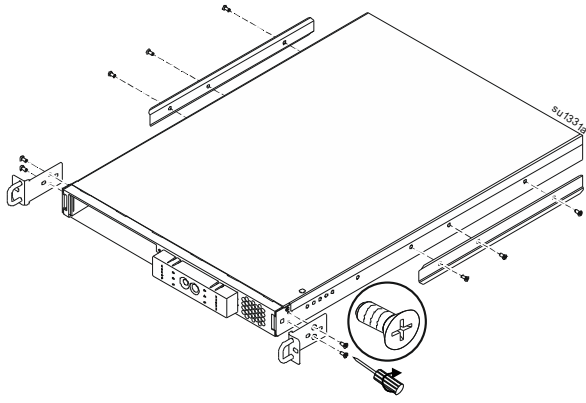

Step 4

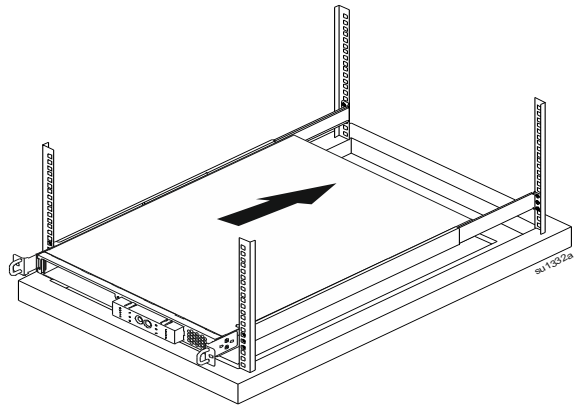

Step 5

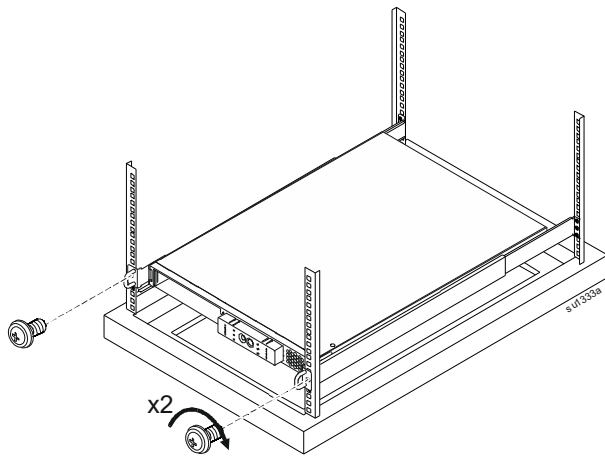

Check to make sure the rack will not tip after installing the UPS into the rack.

Installing and Connecting the Battery and Attaching the Front Bezel

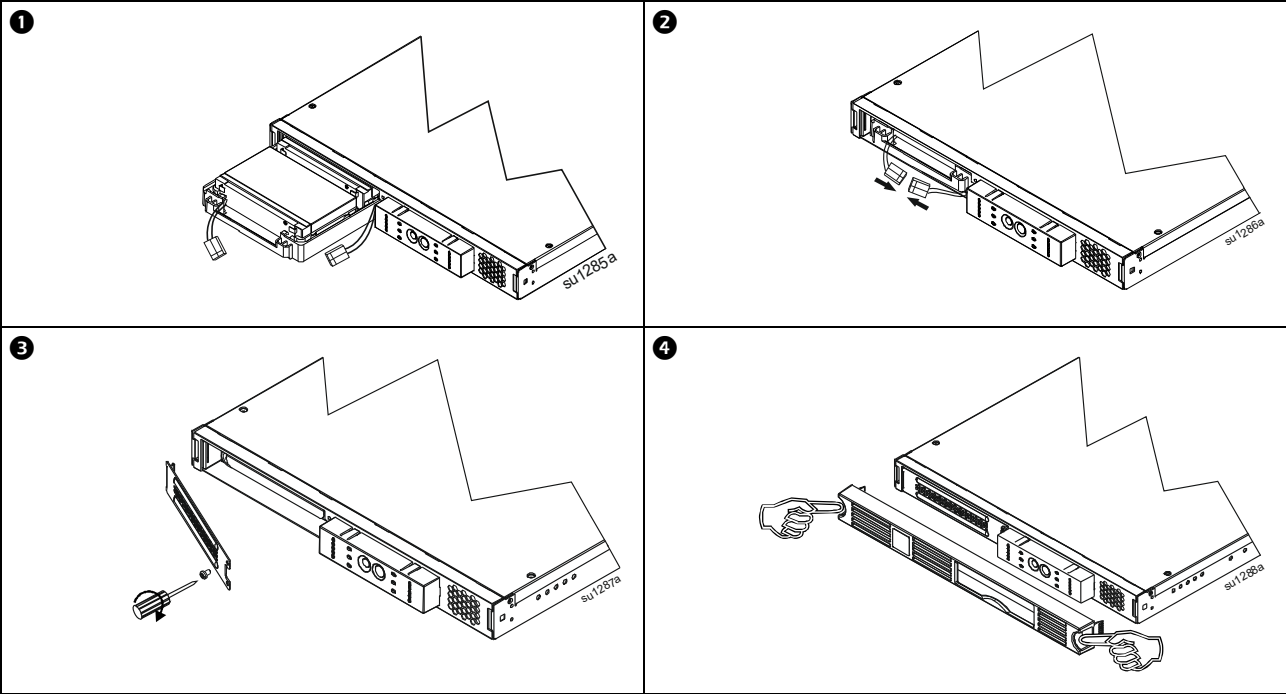

Connecting Equipment and Power to the UPS

Smart-UPS Rear Panel

230 V models

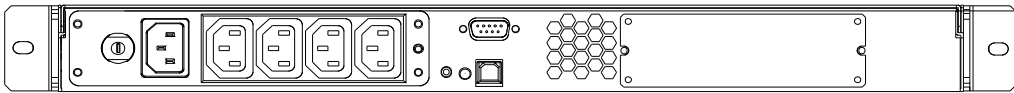

120/100 V models

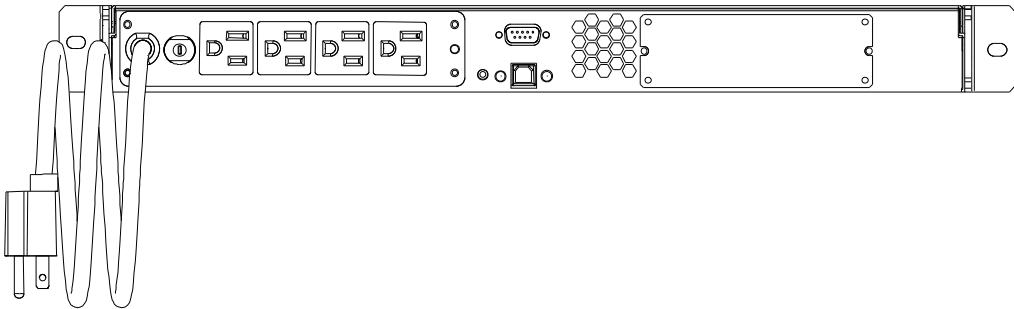

1. Connect equipment to the UPS.

NOTE: Do not connect a laser printer to the UPS. A laser printer draws significantly more power than other types of equipment and may overload the UPS.

2. Add any optional accessories to the SmartSlot.

3. Using a power cord, plug the UPS into a two pole, three-wire, grounded receptacle only. Avoid using extension cords.

120/100V models: The power cord is permanently attached to the rear panel of the UPS.

4. Turn on all connected equipment. To use the UPS as a master ON/OFF switch, be sure all connected equipment is switched ON. The equipment will not be powered until the UPS is turned on.



5. To power up the UPS press the  button on the front panel.

The UPS charges its battery when it is connected to utility power. The battery charges to 90% capacity during the first three hours of normal operation. **Do not** expect full battery run capability during this initial charge period.

120V Models: Check the site wiring fault LED located on the rear panel. It lights up if the UPS is plugged into an improperly wired utility power outlet. Refer to Troubleshooting in this manual.

6. For additional computer system security, install PowerChute™ Smart-UPS monitoring software.

Basic Connectors

Serial Port 	USB Port 	Power management software and interface kits can be used with the UPS. Use only interface kits supplied or approved by APC by Schneider Electric.
		<p>Use an APC by Schneider Electric supplied cable to connect to the Serial Port. DO NOT use a standard serial interface cable since it is incompatible with the UPS connector.</p> <p>Both Serial and USB Ports are provided. They cannot be used simultaneously.</p>

Operation

Smart-UPS Front Panel

230/100 V models

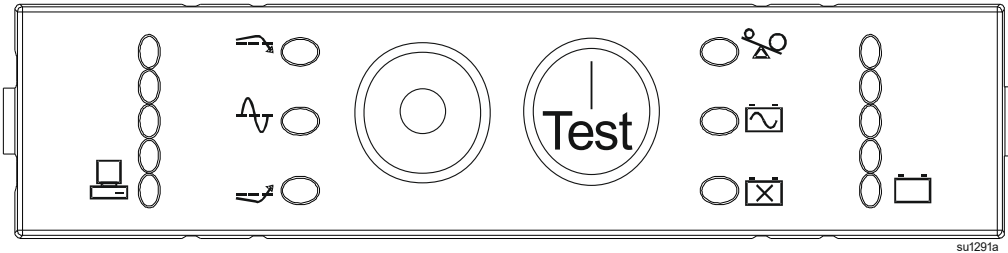

sur1291a

100 V models

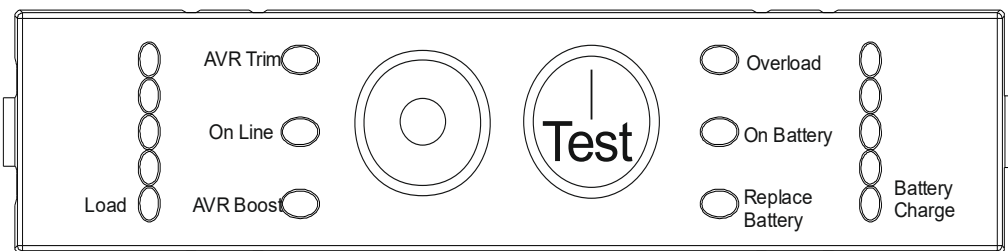

sur1292a

Power On







Power Off



	120V	100/230V	120V	100/230V
	0 85%	0 85%	0 96%	0 96%
	0 67%	0 67%	0 72%	0 72%
	0 50%	0 50%	0 48%	0 48%
	0 33%	0 33%	0 24%	0 24%
	0 17%	0 17%	0 0%	0 0%
Load			Battery Charge	

Online 	The online LED illuminates when the UPS is supplying utility power to the connected equipment. If the LED is not lit, the UPS is either not turned on, or is supplying battery power.
AVR Trim 	This LED illuminates to indicate the UPS is compensating for a high utility voltage.
AVR Boost 	This LED illuminates to indicate the UPS is compensating for a low utility voltage.
On Battery 	When the on battery power LED is lit the UPS is supplying battery power to the connected equipment. When on battery, the UPS sounds an alarm - four beeps every 30 seconds.
Overload Overload 	The LED illuminates and the UPS emits a sustained alarm tone when an overload condition occurs.

Replace Battery 	When the battery does not pass the self test, the UPS emits short beeps for one minute and the Replace Battery LED illuminates. Refer to Troubleshooting in this manual.
Battery Disconnected 	The Replace Battery LED flashes and short beep is emitted every two seconds to indicate the battery is disconnected.
Automatic Self Test	The UPS performs a self-test automatically when turned on, and every two weeks thereafter (by default). During the self-test, the UPS briefly operates the connected equipment on battery. If the UPS does not pass the self-test, the Replace Battery LED  lights and immediately returns to online operation. The connected equipment is not affected. Recharge the battery for 24 hours and perform another self-test. If it is not able to pass the test, the battery must be replaced.
Manual Self Test	Press and hold the  button for a few seconds to initiate the self-test.

On Battery Operation

The Smart-UPS switches to battery operation automatically when there is an utility power outage. While running on battery, an alarm beeps four times every 30 seconds.

Press the  button (front panel) to silence the UPS alarm for the current alarm only. If the utility power does not return, the UPS continues to supply power to the connected equipment until the battery is exhausted.

If PowerChute is not being used you must manually save your files and power down before the UPS turns off.











Determining On Battery Run Time

UPS battery life differs based on usage and environment. It is recommended that the battery/batteries be changed once every three years. See the APC by Schneider Electric web site, www.apc.com, for on battery run times.

User Configurable Items

NOTE: Settings are made through supplied PowerChute software or optional SmartSlot accessory cards.

Function	Factory Default	User Selectable Choices	Description
Automatic Self-Test	Every 14 days (336 hours)	Every 7 days (168 hours), On Startup Only, No Self Test	This function sets the interval at which the UPS will execute a self-test. Refer to the software manual for details.
UPS ID	UPS_IDEN	Up to eight characters to define the UPS	Use this field to uniquely identify the UPS, (ie. server name or location) for network management purposes.
Date of Last Battery Replacement	Manufacture Date	Date of Battery Replacement mm/dd/yy	Reset this date when you replace the battery module.
Minimum Capacity Before Return from Shutdown	0 percent	15, 30, 45, 50, 60, 75, 90 percent	The UPS will charge its batteries to the specified percentage before return from a shutdown.

Function	Factory Default	User Selectable Choices	Description
Voltage Sensitivity The UPS detects and reacts to line voltage distortions by transferring to battery operation to help protect the connected equipment. Where power quality is poor, the UPS may frequently transfer to battery operation. If the connected equipment can operate normally under such conditions, reduce the sensitivity setting to conserve battery capacity and service life.	 High	Brightly lit: UPS is set to high sensitivity. Dimly lit: UPS is set to medium sensitivity. Off: UPS is set to low sensitivity.  High  Medium  Low	To change the UPS sensitivity, press the voltage sensitivity button  (rear panel). Use a pointed object (such as a pen) to do so. You can change the sensitivity level through PowerChute software.
Alarm Control	Enable	Mute, Disable	User can mute a present ongoing alarm or disable all existing alarms permanently.
Shutdown Delay	90 seconds	0, 180, 270, 360, 450, 540, 630 seconds	Sets the interval between the time when the UPS receives a shutdown command and actual shutdown.
Low Battery Alarm. PowerChute interface software provides automatic, unattended shutdown when approximately two minutes (by default) of battery operated run time remains.	 2 min.	Brightly lit: Low battery alarm interval is about two minutes. Dimly lit: Low battery alarm interval is about five minutes. Off: Low battery alarm interval is about eight minutes.  2 min.  5 min.  8 min. Possible interval settings: 2, 5, 8, 11, 14, 17, 20, 23 minutes.	The low battery alarm beeps are continuous when two minutes of run time remain. To change the alarm interval default setting, press the voltage sensitivity button (use a pointed object such as a pen to do so), while pressing and holding the  button (front panel).
Synchronized Turn on Delay	0 seconds	60, 120, 180, 240, 300, 360, 420 seconds	The UPS will wait the specified time after the return of utility power before turn on (to avoid branch circuit overload).
High Transfer Point	230V models: 253 Vac 120V models: 127 Vac 100V models: 108 Vac	230V models: 257, 261, 265 Vac 120V models: 130, 133, 136 Vac 100V models: 110, 112, 114 Vac	To avoid unnecessary battery usage, set the high transfer point higher if the utility voltage is chronically high and the connected equipment is known to work under this condition.
Low Transfer Point	230V models: 208 Vac 120V models: 106 Vac 100V models: 92 Vac	230V models: 196, 200, 204 Vac 120V models: 97, 100, 103 Vac 100V models: 86, 88, 90 Vac	Set the low transfer point lower if the utility voltage is chronically low and the connected equipment can tolerate this condition.
Output Voltage	230V models: 230Vac	230V models: 220, 225, 240Vac	230V models ONLY: Allows the user to select the on battery output voltage.

Specifications

Temperature	Operating	0 to 40 °C (32 to 104 °F)
	Storage	-15 to 45 °C (5 to 113 °F)
Maximum Elevation	Operating	2,000 m (6,562 ft)
	Storage	15,240 m (50,000 ft)
Humidity		0 to 95% relative humidity, non condensing
International Protection Code		IP20
Applicable power grid power distribution system		TN Power System
Applicable Standard		IEC 62040-1
Pollution Degree		2
Overvoltage Category		II

Storage

Store the UPS covered and positioned as for proper functioning, in a cool, dry location, with the batteries fully charged.

At -15° to +30° C (+5° to +86° F), charge the UPS battery every six months.

At +30° to +45° C (+86° to +113° F), charge the UPS battery every three months.

Replacing the Battery Module

This UPS has an easy to replace, swappable battery module, isolated from electrical hazards. You may leave the UPS and connected equipment on for the following procedure. See your dealer or contact APC by Schneider Electric at the web site, www.apc.com for information on replacement battery modules.



Once the battery is disconnected, the connected equipment is not protected from power outages. Be careful during the following steps—the battery module is heavy.

Refer to Installing and Connecting the Battery and Attaching the Front Bezel, in this manual.

Reverse the instructions for battery removal.

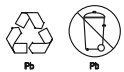

Be sure to deliver the spent battery to a recycling facility or ship it to APC by Schneider Electric in the replacement battery packing material.

Disconnecting the Battery for Transport



Always DISCONNECT THE BATTERY before shipping in compliance with U.S. Department of Transportation (DOT) regulations.

The battery may remain in the UPS; it does not have to be removed.

Shut down and disconnect any equipment attached to the UPS.





Shut down and disconnect the UPS from the power supply.



Unplug the battery connector. Refer to Mounting the UPS in a Rack, Steps 1 and 2 in this manual.



For shipping instructions and to obtain appropriate packing materials contact APC by Schneider Electric at the web site, www.apc.com/support/contact.

Troubleshooting

Use the chart below to solve minor Smart-UPS installation and operation problems. Refer to the APC by Schneider Electric web site, www.apc.com, for assistance with complex UPS problems.

Problem and Possible Cause	Solution
UPS will not turn on	
Battery not connected properly.	Check that the battery connector is fully engaged.
 button not pushed.	Press the  button once to power the UPS and the connected equipment.
UPS not connected to utility power supply.	Check that the power cable from the UPS to the utility power supply is securely connected at both ends.
Very low or no utility voltage.	Check the utility power supply to the UPS by plugging in a table lamp. If the light is very dim, have the utility voltage checked.
UPS will not turn off	
 button not pushed.	Press the  button once to turn the UPS off.
Internal error detected.	Do not attempt to use the UPS. Unplug the UPS and have it serviced immediately.
UPS beeps occasionally	
Normal UPS operation when running on battery.	None. The UPS is helping protect the connected equipment.
UPS does not provide expected backup time	
The UPS battery is weak due to a recent outage or is near the end of its service life.	Charge the battery. Batteries require recharging after extended outages. They wear faster when put into service often or when operated at elevated temperatures. If the battery is near the end of its service life, consider replacing the battery even if the replace battery LED is not yet lit.
All LEDs are lit and the UPS emits a constant beeping	
Internal error detected.	Do not attempt to use the UPS. Turn the UPS off and have it serviced immediately.
Front panel LEDs flash sequentially	
The UPS has been shut down remotely through software or an optional accessory card.	None. The UPS will restart automatically when utility power returns.
All LEDs are off and the UPS is plugged into a wall outlet	
The UPS is shut down and the battery is discharged from an extended outage.	None. The UPS will return to normal operation when the power is restored and the battery has a sufficient charge.
The overload LED is lit and the UPS emits a sustained alarm tone	
The UPS is overloaded.	<p>The connected equipment exceeds the specified “maximum load” as defined in Specifications at the APC by Schneider Electric web site, www.apc.com.</p> <p>The alarm remains on until the overload is removed. Disconnect nonessential equipment from the UPS to eliminate the overload.</p> <p>The UPS continues to supply power as long as it is online and the circuit breaker does not trip; the UPS will not provide power from batteries in the event of a utility voltage interruption.</p> <p>If a continuous overload occurs while the UPS is on battery, the unit turns off output in order to help protect the UPS from possible damage.</p>

Problem and Possible Cause	Solution
The Replace Battery LED is lit	
Replace Battery LED flashes and short beep is emitted every two seconds to indicate the battery is disconnected.	Check that the battery connectors are fully engaged.
Weak battery.	Allow the battery to recharge for 24 hours. Then, perform a self-test. If the problem persists after recharging, replace the battery.
Battery has not passed the self-test.	The UPS emits short beeps for one minute and the Replace Battery LED illuminates. The UPS repeats the alarm every five hours. Perform the self-test procedure after the battery has charged for 24 hours to confirm the replace battery condition. The alarm stops and the LED clears if the battery passes the self test.
The Site Wiring Fault LED is lit	
120V models only. Site wiring LED  on rear panel. The UPS is plugged into an improperly wired utility power outlet.	Wiring faults detected include missing ground, line neutral polarity reversal, and overloaded neutral circuit. Contact a qualified electrician to correct the building wiring.
The Input Circuit Breaker trips	
The plunger on the circuit breaker  (located to the right of the input cable connection) pops out.	Reduce the load on the UPS by unplugging equipment and press the plunger in.
AVR Boost or AVR Trim LEDs light	
Your system is experiencing excessive periods of low or high voltage.	Have qualified service personnel check your facility for electrical problems. If the problem continues, contact the utility company for further assistance.
UPS operates on battery although normal line voltage exists	
UPS input circuit breaker tripped.	Reduce the load on the UPS by unplugging equipment and resetting the circuit breaker (on the back of UPS) by pressing the plunger in.
Very high, low, or distorted line voltage. Inexpensive fuel powered generators can distort the voltage.	Move the UPS to a different outlet on a different circuit. Test the input voltage with the utility voltage display (see below). If acceptable to the connected equipment, reduce the UPS sensitivity.
Battery Charge and Battery Load LEDs flash simultaneously	
The internal temperature of the UPS has exceeded the allowable threshold for operation.	Check that the room temperature is within the specified limits for operation. Check that the UPS is properly installed allowing for adequate ventilation. Allow the UPS to cool down. Restart the UPS. If the problem continues contact APC by Schneider Electric at, www.apc.com/support .

Problem and Possible Cause	Solution
Diagnostic Utility Voltage Feature	
Utility Voltage 100V 230V 120V 0 119 0 266 0 133 0 110 0 248 0 124 0 100 0 229 0 114 0 91 0 213 0 105 0 82 0 196 0 96  Battery Charge	<p>The UPS has a diagnostic feature that displays the utility voltage. Plug the UPS into the normal utility power.</p> <p>Press and hold the  button to view the utility voltage bar graph display. After a few seconds the five LED, Battery Charge, , display on the right of the front panel shows the utility input voltage.</p> <p>Refer to the figure at left for the voltage reading (values are not listed on the UPS). The display indicates the voltage is between the displayed value on the list and the next higher value.</p> <p>Three LEDs light, indicating utility voltage within the normal range.</p> <p>If no LEDs are lit and the UPS is plugged into a working utility power outlet, the line voltage is extremely low.</p> <p>If all five LEDs are lit, the line voltage is extremely high and should be checked by an electrician.</p>

NOTE: The UPS starts a self-test as part of this procedure. The self-test does not affect the voltage display.

Transport and Service

Transport

1. Shut down and disconnect all connected equipment.
2. Disconnect the unit from utility power.
3. Disconnect all internal and external batteries (if applicable).
4. Follow the shipping instructions outlined in the Service section of this manual.

Service

1. If the unit requires service, do not return it to the dealer. Follow these steps:
2. Review the Troubleshooting section of the manual to eliminate common problems.
3. If the problem persists, contact APC by Schneider Electric Customer Support through the APC by Schneider Electric web site, www.apc.com.
4. Note the model number and serial number and the date of purchase. The model and serial numbers are located on the rear panel of the unit and are available through the LCD display on select models.
5. Call Customer Support and a technician will attempt to solve the problem over the phone. If this is not possible, the technician will issue a Returned Material Authorization Number (RMA#).
6. If the unit is under warranty, the repairs are free.
7. Service procedures and returns may vary internationally. Refer to the APC by Schneider Electric web site, www.apc.com for country specific instructions.
8. Pack the unit properly to avoid damage in transit. Never use foam beads for packaging. Damage sustained in transit is not covered under warranty.
9. Note: When shipping within the United States, or to the United States always DISCONNECT ONE UPS BATTERY before shipping in compliance with U.S. Department of Transportation (DOT) and IATA regulations. The internal batteries may remain in the UPS.
10. Batteries may remain connected in the XBP during shipment. Not all units utilize XLBPs.
11. Write the RMA# provided by Customer Support on the outside of the package.
12. Return the unit by insured, prepaid carrier to the address provided by Customer Support.

Limited Factory Warranty

Schneider Electric IT Corporation (SEIT), warrants its products to be free from defects in materials and workmanship for a period of two (2) years from the date of purchase. The SEIT obligation under this warranty is limited to repairing or replacing, at its own sole option, any such defective products. Repair or replacement of a defective product or parts thereof does not extend the original warranty period.

This warranty applies only to the original purchaser who must have properly registered the product within 10 days of purchase. Products may be registered online at warranty.apc.com.

SEIT shall not be liable under the warranty if its testing and examination disclose that the alleged defect in the product does not exist or was caused by end user or any third person misuse, negligence, improper installation, testing, operation or use of the product contrary to SEIT recommendations or specifications. Further, SEIT shall not be liable for defects resulting from: 1) unauthorized attempts to repair or modify the product, 2) incorrect or inadequate electrical voltage or connection, 3) inappropriate on site operation conditions, 4) Acts of God, 5) exposure to the elements, or 6) theft. In no event shall SEIT have any liability under this warranty for any product where the serial number has been altered, defaced, or removed.

EXCEPT AS SET FORTH ABOVE, THERE ARE NO WARRANTIES, EXPRESS OR IMPLIED, BY OPERATION OF LAW OR OTHERWISE, APPLICABLE TO PRODUCTS SOLD, SERVICED OR FURNISHED UNDER THIS AGREEMENT OR IN CONNECTION HERewith. SEIT DISCLAIMS ALL IMPLIED WARRANTIES OF MERCHANTABILITY, SATISFACTION AND FITNESS FOR A PARTICULAR PURPOSE. SEIT EXPRESS WARRANTIES WILL NOT BE ENLARGED, DIMINISHED, OR AFFECTED BY AND NO OBLIGATION OR LIABILITY WILL ARISE OUT OF, SEIT RENDERING OF TECHNICAL OR OTHER ADVICE OR SERVICE IN CONNECTION WITH THE PRODUCTS. THE FOREGOING WARRANTIES AND REMEDIES ARE EXCLUSIVE AND IN LIEU OF ALL OTHER WARRANTIES AND REMEDIES. THE WARRANTIES SET FORTH ABOVE CONSTITUTE SEIT SOLE LIABILITY AND PURCHASER EXCLUSIVE REMEDY FOR ANY BREACH OF SUCH WARRANTIES. SEIT WARRANTIES EXTEND ONLY TO ORIGINAL PURCHASER AND ARE NOT EXTENDED TO ANY THIRD PARTIES. IN NO EVENT SHALL SEIT, ITS OFFICERS, DIRECTORS, AFFILIATES OR EMPLOYEES BE LIABLE FOR ANY FORM OF INDIRECT, SPECIAL, CONSEQUENTIAL OR PUNITIVE DAMAGES, ARISING OUT OF THE USE, SERVICE OR INSTALLATION OF THE PRODUCTS, WHETHER SUCH DAMAGES ARISE IN CONTRACT OR TORT, IRRESPECTIVE OF FAULT, NEGLIGENCE OR STRICT LIABILITY OR WHETHER SEIT HAS BEEN ADVISED IN ADVANCE OF THE POSSIBILITY OF SUCH DAMAGES. SPECIFICALLY, SEIT IS NOT LIABLE FOR ANY COSTS, SUCH AS LOST PROFITS OR REVENUE, WHETHER DIRECT OR INDIRECT, LOSS OF EQUIPMENT, LOSS OF USE OF EQUIPMENT, LOSS OF SOFTWARE, LOSS OF DATA, COSTS OF SUBSTITUANTS, CLAIMS BY THIRD PARTIES, OR OTHERWISE. NOTHING IN THIS LIMITED WARRANTY SHALL SEEK TO EXCLUDE OR LIMIT SEIT LIABILITY FOR DEATH OR PERSONAL INJURY RESULTING FROM ITS NEGLIGENCE OR ITS FRAUDULENT MISREPRESENTATION OF TO THE EXTENT THAT IT CANNOT BE EXCLUDED OR LIMITED BY APPLICABLE LAW.

To obtain service under warranty you must obtain a Returned Material Authorization (RMA) number from customer support. Customers with warranty claims issues may access the SEIT worldwide customer support network through the APC web site: www.apc.com. Select your country from the country selection drop down menu. Open the Support tab at the top of the web page to obtain information for customer support in your region. Products must be returned with transportation charges prepaid and must be accompanied by a brief description of the problem encountered and proof of date and place of purchase.

APC by Schneider Electric Worldwide Customer Support

Customer support for this or any other APC by Schneider Electric product is available at no charge in any of the following ways:

- Visit the APC by Schneider Electric web site, www.apc.com to access documents in the APC Knowledge Base and to submit customer support requests.
 - **www.apc.com** (Corporate Headquarters)
Connect to localized APC by Schneider Electric web site for specific countries, each of which provides customer support information.
 - **www.apc.com/support/**
Global support searching APC Knowledge Base and using e-support.
- Contact the APC by Schneider Electric Customer Support Center by telephone or e-mail.
 - Local, country specific centers: go to **www.apc.com/support/contact** for contact information.
 - For information on how to obtain local customer support, contact the APC by Schneider Electric representative or other distributor from whom you purchased your APC by Schneider Electric product.